

# User Manual SWV(EN) V1.0



Zigbee Smart Water Valve

User Manual V1.0

## Introduction

A Zigbee Smart Water Valve powered by four AA batteries, which easy and quick to install. You can remotely control and set scheduled irrigation, quantitative irrigation, intelligent scenes and so on through the APP to make the traditional irrigation system intelligent. It supports statistics of irrigation water consumption, and can view 6-month historical records at any time, helping you better manage water resources and save water bills.



APP control



Timed watering



Cyclic irrigation



Water consumption statistics



6-month history



Scene linkage

\*The functional characteristics depend on the functionality of Zigbee gateway.

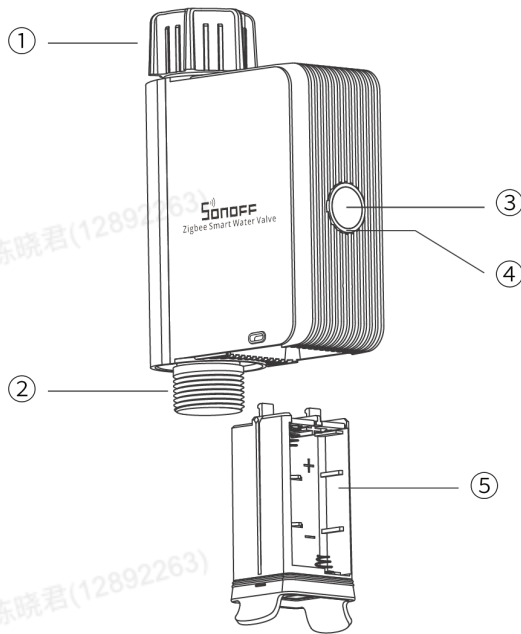

① Inlet

② Outlet

③ Button

- Single press: Turn on/off the smart device.
- Press and hold for 5 seconds: The device enters the pairing mode.

④ LED indicator (Green)

- Steady on: Normal connection with the gateway.
- Slow flash: The device is in pairing mode.
- Fast flash: Abnormal connection with the gateway.

⑤ Battery slot

## Compatible Voice Assistants



# Specification

Model	SWV-NH, SWV-BSP
MCU	EFR32MG22
Rating	6V <sub>==</sub> (4*1.5V AA)
Wireless connection	Zigbee 3.0
Communication distance	130M (open space)
Waterproof	IP55
Working Pressure	0.06~0.8 MPa
Net weight	278g
Dimension	152x100x46mm
Color	Black
Casing materials	PC+ABS
Working Temperatur	5~60°C
Watering Temperatur	5~40°C
Working humidity	5%~95% RH, non-condensing
Working altitude	≤2000M
Certification	CE/FCC/ISED
Executive standard	EN62368-1

## Download the eWeLink App & Add SONOFF Zigbee Gateway

Please download the "eWeLink" App from Google Play Store or Apple App Store.

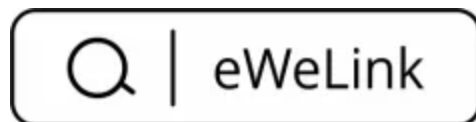

## Power On the Device

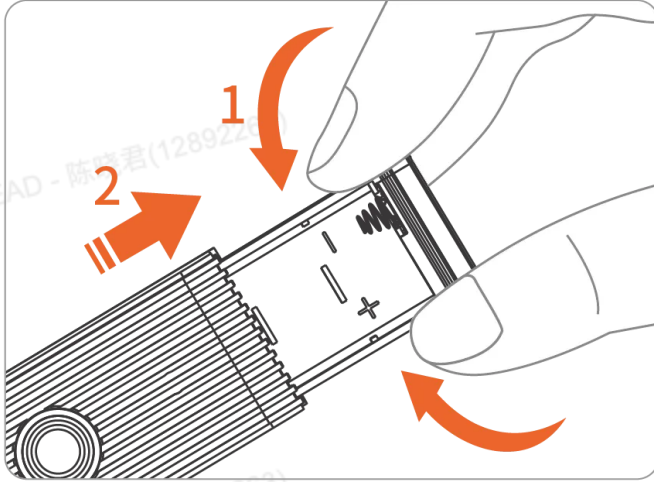

① Hold both ends of the battery compartment cover and pull out the battery slot.

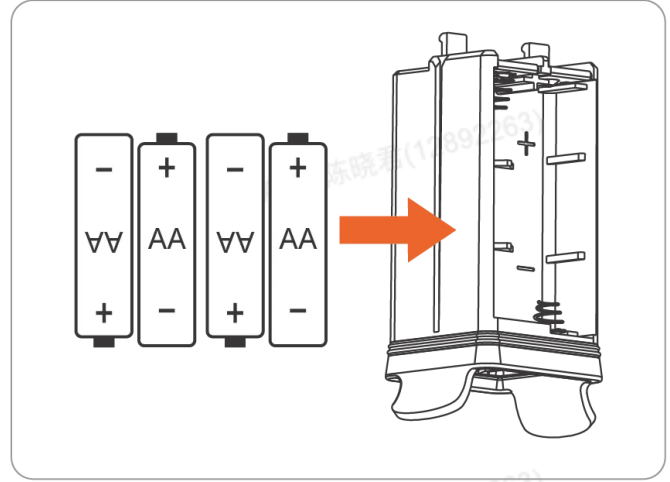

② Install four AA batteries.

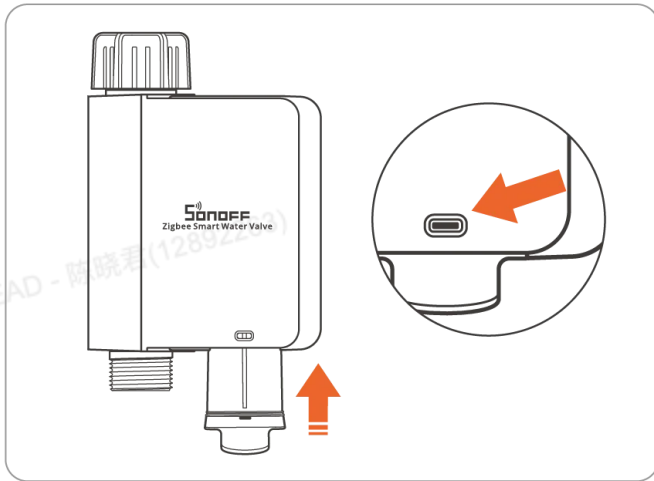

③ Firmly press the battery slot into the device until the snap at the arrow is visible.

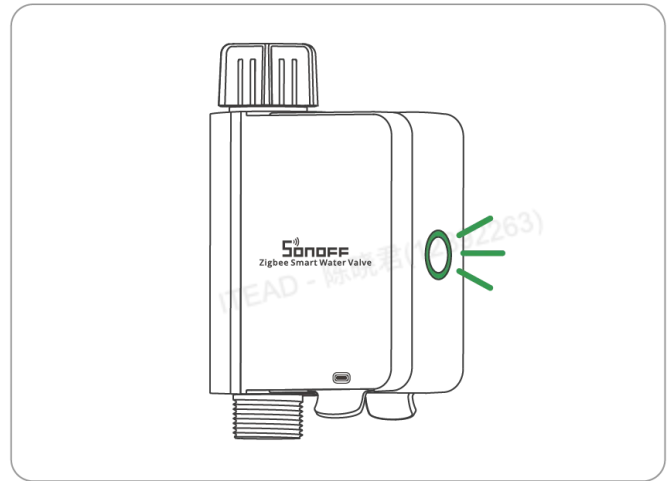

④ After powering on, the button LED light flashes.

## Scan QR Code to Add Device

ITEAD - 陈晓君(12892263)

ITEAD - 陈晓君(12892263)

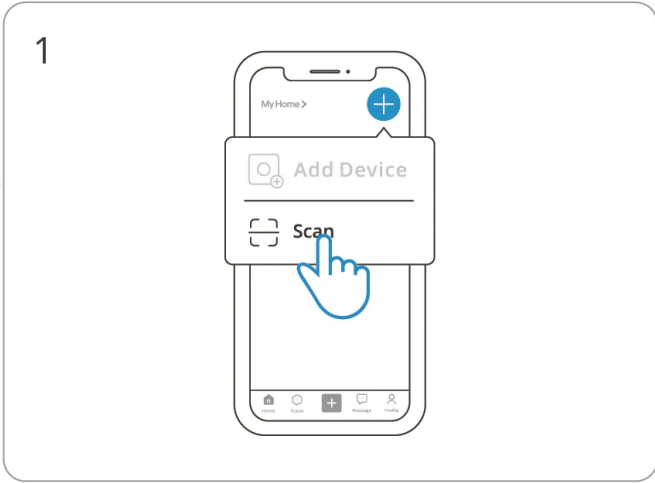

Enter "Scan"

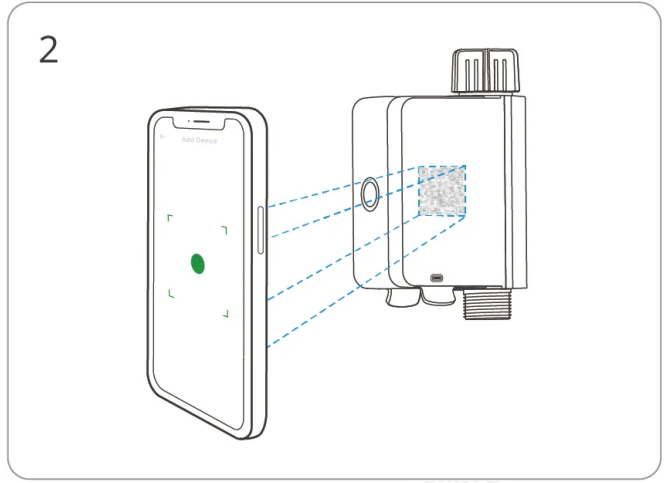

Scan the QR code on the device

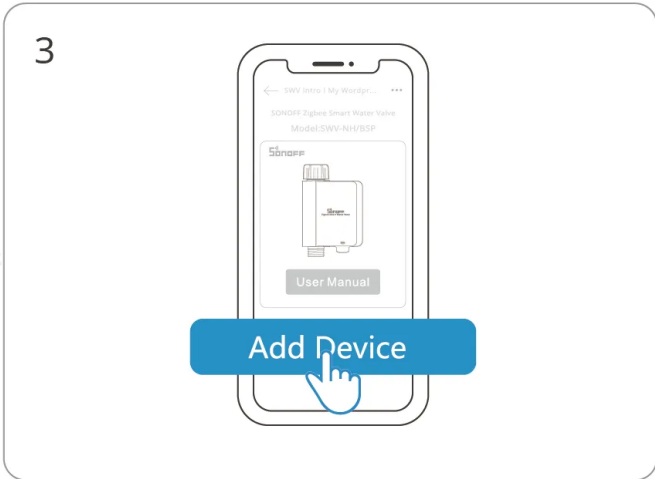

Select "Add Device"



Long press the button for 5 seconds

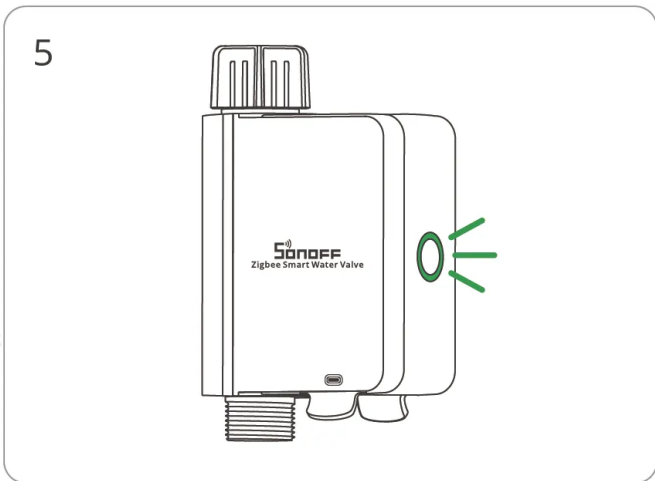

The LED indicator flashes slowly for 180s

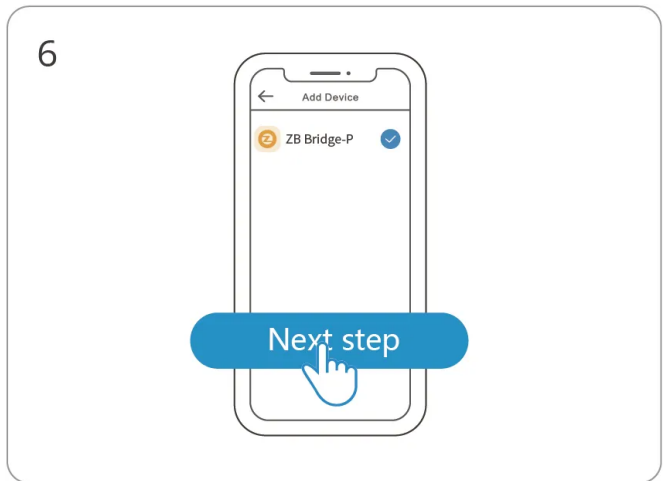

Select Zigbee gateway

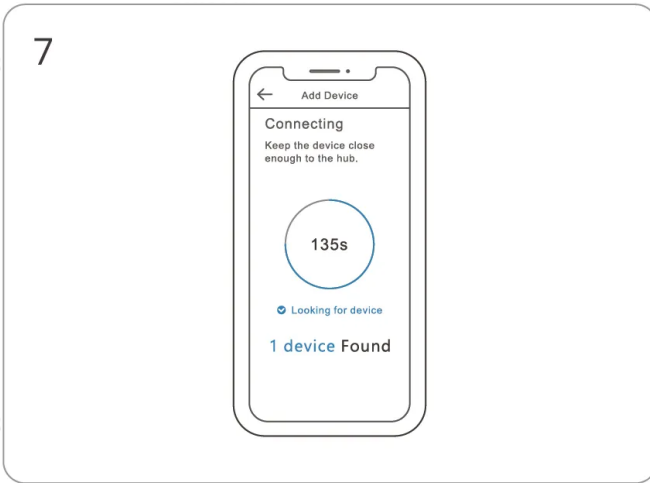

Wait until the addition is done

## Matched Gateways

Recommended SONOFF gateway models: ZBBridge-P (V2.0.0), NSPanel Pro (V3.3.0), iHost (V2.1.0), ZBBridge-U (soon to be supported)

\*Before adding a device, please upgrade the gateway firmware to the above version or the latest version.

Other compatible SONOFF gateway models: ZBDongel-P, ZBDongel-E

### Third-party compatible gateway models:

Amazon Gateway Model: Echo Plus 2nd, Echo Show 2nd, Echo 4th Gen

\*Other gateways supporting ZigBee3.0 wireless protocol. Detailed information is in accordance with the final product.

## Installation

First, wrap the thread seal tape around the thread of the faucet, then screw the nut of the water inlet of the equipment onto the faucet. After testing that there is no leakage, finally connect the hose to the water outlet of the equipment (if the water outlet leaks, please wrap thread seal tape around the thread of the water outlet).

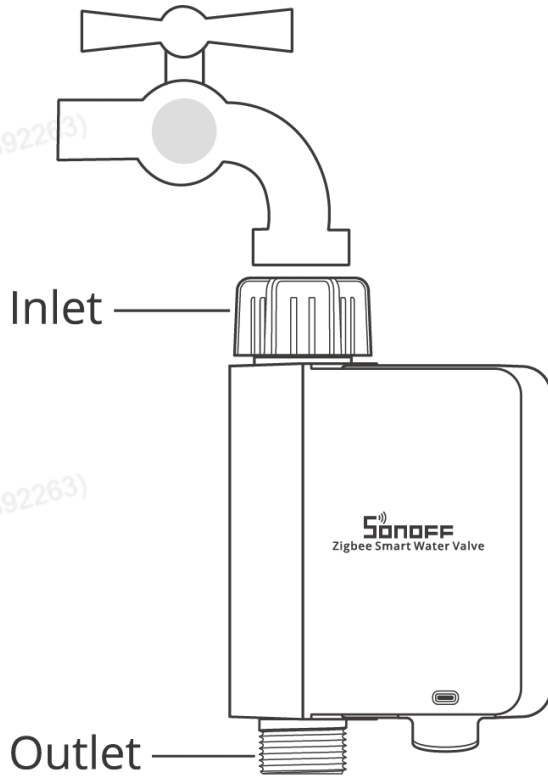

\*It is recommended to install vertically as horizontal installation may increase the error in flow rate measurement.

## Communication Distance

The maximum communication distance of this device is 130M (open space).

## FCC compliance statement

1. This device complies with part 15 of the FCC Rules. Operation is subject to the following two conditions:
  - (1) This device may not cause harmful interference, and
  - (2) This device must accept any interference received, including interference that may cause undesired operation.

2. Changes or modifications not expressly approved by the party responsible for compliance could void the user's authority to operate the equipment.

Note: This equipment has been tested and found to comply with the limits for a Class B digital device, pursuant to part 15 of the FCC Rules. These limits are designed to provide reasonable protection against harmful interference in a residential installation. This equipment generates, uses, and can radiate radio frequency energy and, if not installed and used in accordance with the instructions, may cause harmful interference to radio communications. However, there is no guarantee that interference will not occur in a particular installation. If this equipment does cause harmful interference to radio or television reception, which can be determined by turning the equipment off and on, the user is encouraged to try to correct the interference by one or more of the following measures:

- Reorient or relocate the receiving antenna.
- Increase the separation between the equipment and receiver.
- Connect the equipment to an outlet on a circuit different from that to which the receiver is connected.
- Consult the dealer or an experienced radio/TV technician for help.

FCC Radiation Exposure statement:

This equipment complies with FCC radiation exposure limits set forth for an uncontrolled environment.

This equipment should be installed and operated with a minimum distance of 20 cm between the radiator and your body.

This transmitter must not be co-located or operating in conjunction with any other antenna or transmitter.

## ISED Notice

This device contains license-exempt transmitter(s)/receiver(s) that comply with Innovation, Science and Economic Development Canada's license-exempt RSS(s). Operation is subject to the following two conditions:

- (1) This device may not cause interference.
- (2) This device must accept any interference, including interference that may cause undesired operation of the device.

This Class B digital apparatus complies with Canadian ICES-003(B).



This device complies with RSS-247 of Industry Canada. Operation is subject to the condition that this device does not cause harmful interference.

L'émetteur/récepteur exempt de licence contenu dans le présent appareil est conforme aux CNR d'Innovation, Sciences et Développement économique Canada applicables aux appareils radio exempts de licence. L'exploitation est autorisée aux deux conditions suivantes :

(1) L'appareil ne doit pas produire de brouillage;

(2) L'appareil doit accepter tout brouillage radioélectrique subi, même si le brouillage est susceptible d'en compromettre le fonctionnement.

Cet appareil numérique de la Classe B conforme à la norme NMB-003(B) du Canada.

Cet appareil est conforme à la norme RSS - 247 d'Industrie Canada. Le fonctionnement est soumis à la condition que cet appareil ne provoque pas d'interférences nuisibles.

#### ISED Radiation Exposure Statement

This equipment complies with ISED radiation exposure limits set forth for an uncontrolled environment.

This equipment should be installed and operated with minimum distance of 20 cm between the radiator and your body.

This transmitter must not be co-located or operating in conjunction with any other antenna or transmitter.

Cet équipement est conforme aux limites d'exposition aux rayonnements de la ISED établies pour un environnement non contrôlé.

Cet équipement doit être installé et fonctionner à au moins 20cm de distance d'un radiateur ou de votre corps.

Cet émetteur ne doit pas être co-localisé ou fonctionner en conjonction avec une autre antenne ou un autre émetteur.

## SAR Warning

Under normal use of condition, this equipment should be kept a separation distance of at least 20 cm between the antenna and the body of the user.

Dans des conditions normales d'utilisation, cet équipement doit être maintenu à une distance d'au moins 20 cm entre l'antenne et le corps de l'utilisateur.

## WEEE Disposal and Recycling Information



All products bearing this symbol are waste electrical and electronic equipment (WEEE as in directive 2012/19/EU) which should not be mixed with unsorted householdwaste. Instead, you should protect human health and the environment by handingover your waste equipment to a designated collection point for the recycling of waste electricaland electronic equipment, appointed by the government or local authorities. Correct disposaland recycling will help prevent potential negative consequences to the environment and human health. Please contact the installer or local authorities for more information about thelocation as well as terms and conditions of such collection points.

## EU Declaration of Conformity

Hereby, Shenzhen Sonoff Technologies Co., Ltd declares that the radio equipment type SWV–NH, SWV–BSP is in compliance with Directive 2014/53/EU. The full text of the EU declaration of conformity is available at the following internet address:

<https://sonoff.tech/compliance/>

## For CE frequency

### EU Operating Frequency Range

Zigbee : 2405–2480 MHz

### EU Output Power

Zigbee ≤10dBm

Scatola	Neto	Manuale	Borsa
PAP 21	PAP 20	PAP 22	LDPE4
Carta	Carta	Plastica	Plastica
RACCOLTA DIFFERENZIATA			

Verifica le disposizioni del tuo Comune.

Separa le componenti e conferiscile in modo corretto.

## Cautions

RISK OF EXPLOSION IF BATTERY IS REPLACED BY AN INCORRECT TYPE DISPOSE OF USED BATTERYIES ACCORDING TO THE INSTRUCTIONS

Do not short-circuit batteries.

Do not use new and old batteries together.

Do not use batteries of different types/manufacturers together. Do not use batteries in reverse polarity

A battery which is leaking or has leaked before is not fit for use and should be thrown away.

Place the batteries into a plastic bag, without touching the batteries, put on gloves and an apronand, then put it into a recycling box at an electrical store.

When the battery which is leaking or has leaked before, in some cases, the circuit board of your device may be damaged and will no longer work. In that cases, you should take your device to a Recupel collection point and the battery to a Bebat collection point.

Disposal of a battery into fire or a hot oven, or mechanically crushing or cutting of a battery, that can result in an explosion.

Leaving a battery in an extremely high temperature surrounding environment that can result in an explosion or the leakage of flammable liquid or gas.

A battery subjected to extremely low air pressure that may result in an explosion or the leakage of flammable liquid or gas.



**Shenzhen Sonoff Technologies Co., Ltd.**

3F & 6F, Bldg A, No. 663, Bulong Rd, Shenzhen, Guangdong, China

ZIP code: 518000 Service email: support@itead.cc



**FR**  
Cet appareil et ses accessoires se recyclent

À DÉPOSER EN MAGASIN



OU

À DÉPOSER EN DÉCHÈTERIE



Points de collecte sur [www.quefairedemesdechets.fr](http://www.quefairedemesdechets.fr)  
Privilégiez la réparation ou le don de votre appareil !

